

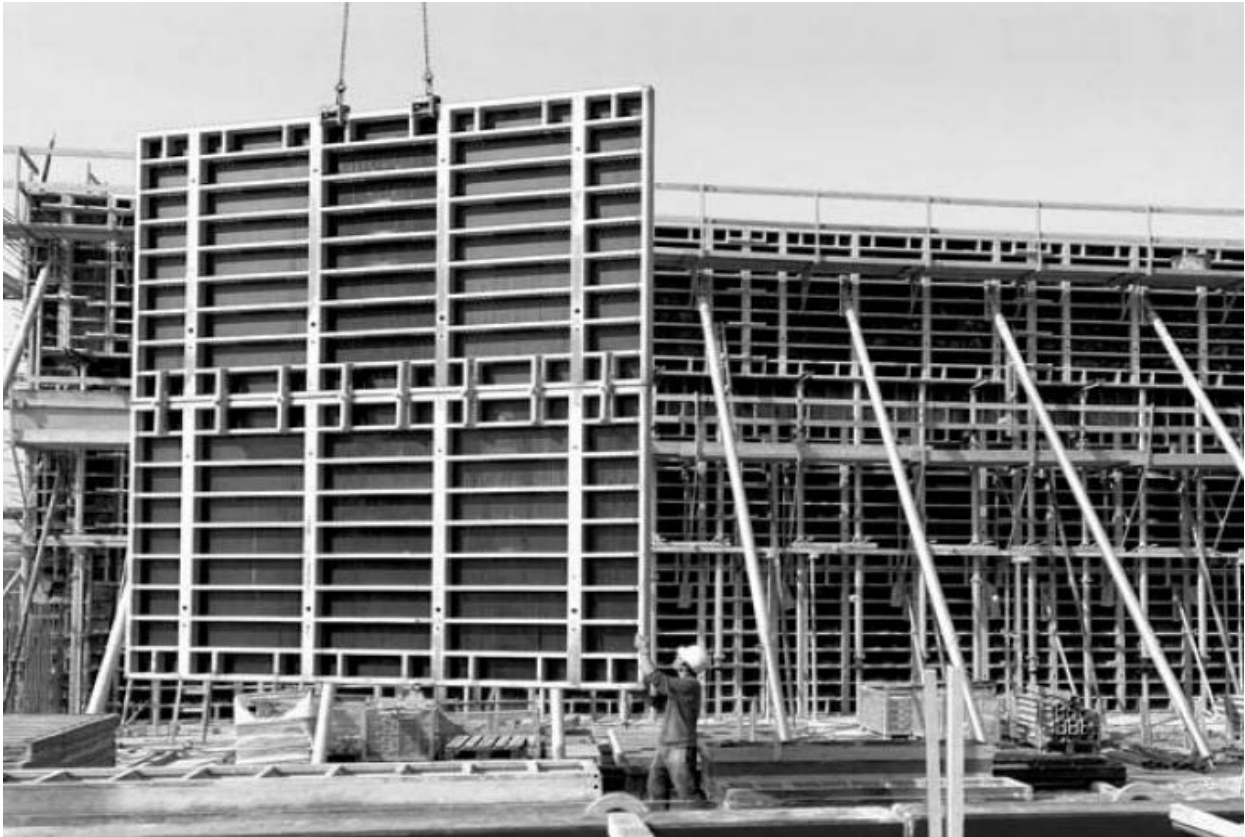

Hünnebeck Manto  
Steypumót

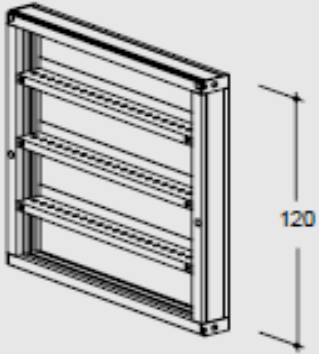

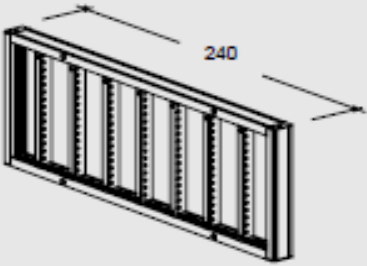
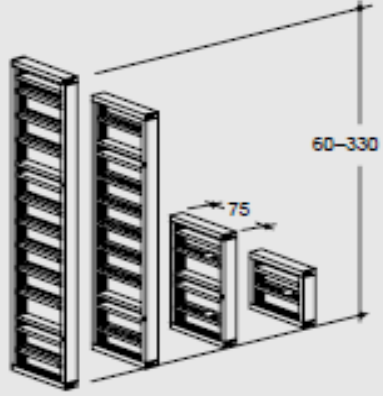
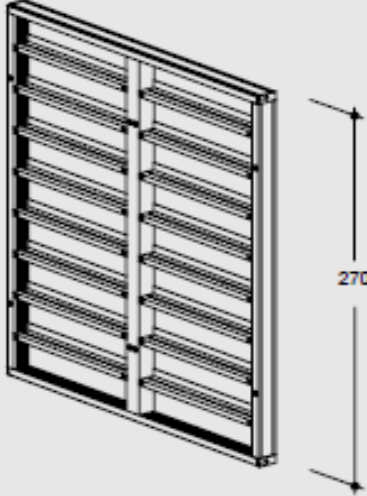

	Vöruheiti	Kg.
<p><b>Basic components</b> panel height 120 cm</p> 	Hb M. Stálflekar 1200/1200	72,83
	Hb M. Stálflekar 1200/1050	65,99
	Hb M. Stálflekar 1200/900	59,18
	Hb M. Stálflekar 1200/750	52,33
	Hb M. Stálflekar 1200/700	49,99
	Hb M. Stálflekar 1200/650	47,68
	Hb M. Stálflekar 1200/600	45,37
	Hb M. Stálflekar 1200/550	43,18
	Hb M. Stálflekar 1200/450	38,56
	Hb M. Stálflekar 1200/300	30,02
<p><b>Extension panels</b></p> 	Hb M. Stálflekar 2400/1200	131,85
	Hb M. Stálflekar 2400/900	107,8
	Hb M. Stálflekar 2400/600	83,83
<p><b>Multi-purpose panels</b></p> 	Hb M. Stálfleki 3300/750 MP	153,46
	Hb M. Stálfleki 2700/750 MP	124,85
	Hb M. Stálfleki 1200/750 MP	67,21
	Hb M. Stálfleki 600/750 MP	37,18

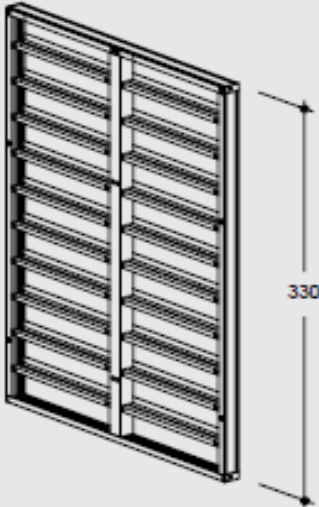
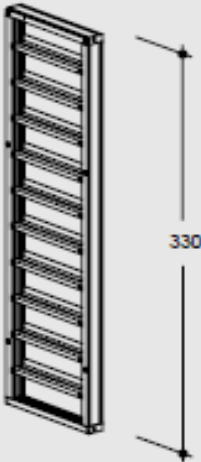
Basic components panel height 270 cm	Vöruheiti	Kg.	
 	Hb M. Stálflekar 3000/2400		
	Hb M. Stálflekar 3000/1200		
	Hb M. Stálflekar 3000/1050		
	Hb M. Stálflekar 3000/900		
	Hb M. Stálflekar 3000/750		
	Hb M. Stálflekar 3000/700		
	Hb M. Stálflekar 3000/650		
	Hb M. Stálflekar 3000/600		
	Hb M. Stálflekar 3000/550		
	Hb M. Stálflekar 3000/450		
	Hb M. Stálflekar 3000/300		

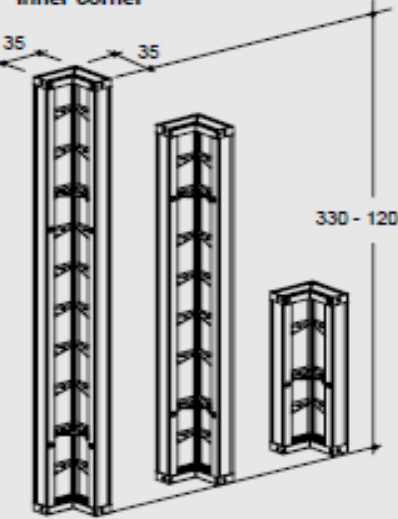
Basic components panel height 330 cm	Vöruheiti	Kg.
	Hb M. Stálflekar 3300/2400	371,03
	Hb M. Stálflekar 3300/1200	179,48
	Hb M. Stálflekar 3300/1050	163,55
	Hb M. Stálflekar 3300/900	164,05
	Hb M. Stálflekar 3300/750	130,19
	Hb M. Stálflekar 3300/700	124,76
	Hb M. Stálflekar 3300/650	119,48
	Hb M. Stálflekar 3300/600	114,16
	Hb M. Stálflekar 3300/550	107,44
	Hb M. Stálflekar 3300/450	96,92
	Hb M. Stálflekar 3300/300	80,68

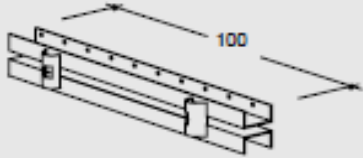
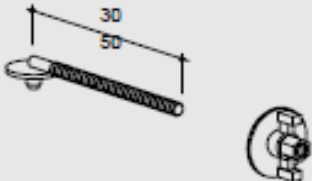
	Vöruheiti	Kg.
<p><b>Corner panels Inner corner</b></p> 		
	Hb M. Innhorn 1200/350/350	45,95
	Hb M. Innhorn 3000/350/350	103,96
	Hb M. Innhorn 3300/350/350	113,66
	Hb M. Stillanlegt innhorn 1200/350/350	54,16
	Hb M. Stillanlegt innhorn 3000/350/350	123,39
	Hb M. Stillanlegt innhorn 3300/350/350	113,66

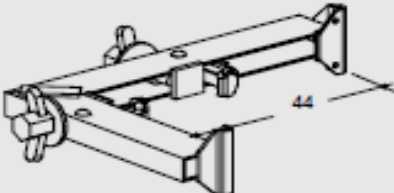
	Vöruheiti	Kg.
	Hb M. Réttскеið 1000mm.	13,1
	Hb M. Festing fyrir réttскеiðar án ró 50cm. Hb M. Festing fyrir réttскеiðar án ró 30cm.	0,76 1,07
<p>Connecting parts</p> 	Hb M. Réttскеiðaklemma	5,5
	Hb M. Úthornaklemma	8,8

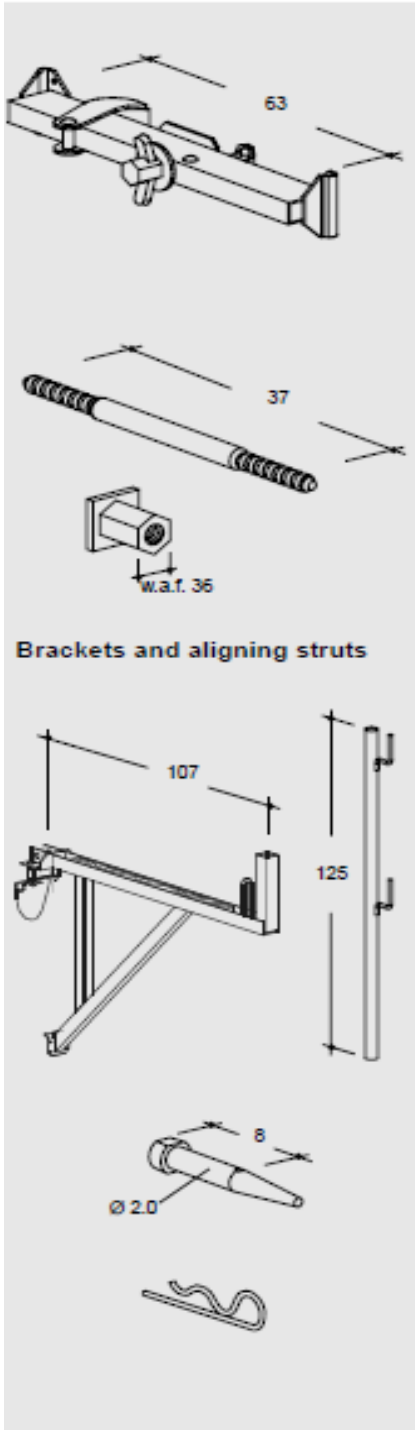

Vöruheiti	Kg.
Hb. M Stillanlegar klemmur	6,00
Hb M. MP bolti	0,80
Hb M. Vinnupallaknekti	12,97
Hb M. handriðapóstur f/vinnupallaknekti	4,50
Hb M. Öryggis bolti f/knekti	0,32

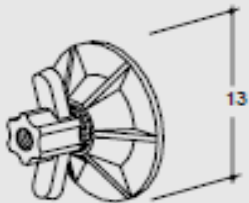
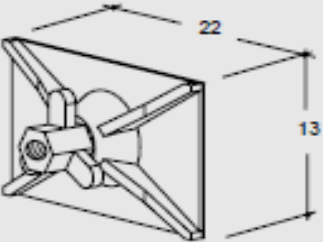
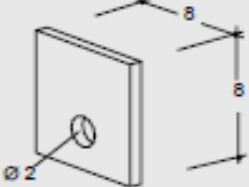
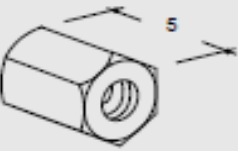
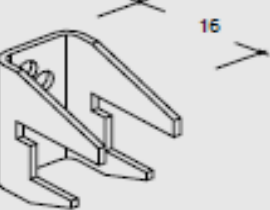
Tying material	Vöruheiti	Kg.
	Hb M. Mótaró tvöföld galv. DW 15	1,26
	Hb M. Mótaró tvöf. galv. DW 15 m/platta	2,40
	Skinna fyrir mótaró	0,40
	Mótaró sexkands 5cm.	0,21
	Hb M. Endaklossi	2,40



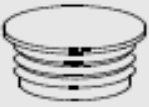

	Vöruheiti	Kg.
		
<p>Accessories</p>		
